



The heating actuator is for activation of electro-thermal actuator drives (ETA) for heating systems or cooling systems. It has 6 electronic outputs, which silently activate the actuator drives in response to EIB telegrams.

Up to 4 electro-thermal actuator drives (e. g. Heimeier 1835, Sauter MTX 116F200, Möhlenhoff AA 2001-00-1) can be connected to each output.

Outputs are actuated either as switching or as a PWM signal, depending on the setting of the manipulated variable (1 bit or 8 bit).

The actuator is able to detect overloads / short circuits at one output / at multiple outputs. In this case the short-circuited outputs after a short identification time can be permanently deactivated; parameters can also be set for overloads to be reported on the bus.

Mains power failures can be reported on the bus.

Summer or winter mode changeover can be performed by object. In addition an anti-seize routine is available for all drives, and cyclic monitoring can be performed for all manipulated variables. If during cyclic monitoring manipulated variable telegrams are found to be missing, emergency mode will be activated for the respective output, using a parameterised manipulated variable defined for summer or winter mode. Emergency mode can also be activated on bus power failure / restoration.

Each output can be positively activated separately by an object. For this a parameterisable manipulated variable, different for summer and winter mode, is assigned to the respective output. Forced position can also be activated on bus power failure / restoration.

In the unprogrammed condition the actuator is set for pulse width modulation with a manipulated variable of 50 % and a cycle time of 15 minutes. This permits the actuator to be tested for functioning even without bus power.

Database structure:

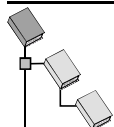

Gebr. Berker

- Heating, air conditioning
- Heating actuator



Application overview:

Switching PWM 206701

Technical data

Protection:	IP 20
Test marks:	EIB
Operating temperature range:	-5 °C to +45 °C
Storage / transport temperature:	-25 °C to +75 °C (storage at over +45 °C will reduce the working life)
Mounting orientation:	any
Dimensions:	4 modules
(W x H x T)	72 x 90 x 64 mm
Mode of fixing:	Snap on DIN rail (no data rail required)

Power supply to instabus EIB system

Voltage:	24 V DC (+6 V / -4 V)
Power consumption:	typically 125 mW
Connection:	instabus connection terminal and tapping block

External supply

Voltage:	230-240 V AC +/- 10 % 50 / 60 Hz																
Power loss:	approx. 2 W, neglecting the power loss at the actuator drives (the power consumption of the device depends on the type and number of the actuator drives that are connected!)																
Connection:	<table> <tr> <td>Screw-type terminals:</td> <td>0.2 – 4</td> <td>mm²</td> <td>solid</td> </tr> <tr> <td></td> <td>2 x 0.2 – 2.5</td> <td>mm²</td> <td>solid</td> </tr> <tr> <td></td> <td>0.75 – 4</td> <td>mm²</td> <td>stranded, without ferrule</td> </tr> <tr> <td></td> <td>0.5 – 2.5</td> <td>mm²</td> <td>stranded, with ferrule</td> </tr> </table>	Screw-type terminals:	0.2 – 4	mm ²	solid		2 x 0.2 – 2.5	mm ²	solid		0.75 – 4	mm ²	stranded, without ferrule		0.5 – 2.5	mm ²	stranded, with ferrule
Screw-type terminals:	0.2 – 4	mm ²	solid														
	2 x 0.2 – 2.5	mm ²	solid														
	0.75 – 4	mm ²	stranded, without ferrule														
	0.5 – 2.5	mm ²	stranded, with ferrule														

Behaviour on power failure

Only bus power:	Programmable (see "Behaviour on bus power failure / bus power restoration", page 24)
Only mains power:	All outputs deactivated (outputs high-resistance) Bus communication exists! Control variables received will be acted upon.
Bus and mains power:	All outputs deactivated (outputs high-resistance)

Behaviour on restoration of power

Only bus power:	Programmable (see "Behaviour on bus power failure / bus power restoration", page 24)
Only mains power:	On restoration of mains power without restoration of bus power the actuator sets all outputs to a PWM of 50 %. A PWM of 50 % (15 minutes cycle time) will also be set after first commissioning, when bus power is indeed present but the actuator is still unprogrammed.
Bus and mains power:	For programmed actuators: software-dependent For unprogrammed actuators: PWM 50 % (15 minute cycle time)

Input:

Output:

Number:	6																
Switch type:	Triac																
Nominal voltage:	230-240 V AC +/- 10 % 50 / 60 Hz (dependent on the incoming mains voltage)																
Rated current:	50 mA resistive per output																
Inrush current	max. 1.5 A short-time																
Minimum load:	1 actuator drive (2 W)																
Number of connectable loads:	max. 4 actuator drives per output (even from different manufacturers)																
Connection:	<table> <tr> <td>Screw-type terminals:</td> <td>0.2 – 4</td> <td>mm²</td> <td>solid</td> </tr> <tr> <td></td> <td>2 x 0.2 – 2.5</td> <td>mm²</td> <td>solid</td> </tr> <tr> <td></td> <td>0.75 – 4</td> <td>mm²</td> <td>stranded, without ferrule</td> </tr> <tr> <td></td> <td>0.5 – 2.5</td> <td>mm²</td> <td>stranded, with ferrule</td> </tr> </table>	Screw-type terminals:	0.2 – 4	mm ²	solid		2 x 0.2 – 2.5	mm ²	solid		0.75 – 4	mm ²	stranded, without ferrule		0.5 – 2.5	mm ²	stranded, with ferrule
Screw-type terminals:	0.2 – 4	mm ²	solid														
	2 x 0.2 – 2.5	mm ²	solid														
	0.75 – 4	mm ²	stranded, without ferrule														
	0.5 – 2.5	mm ²	stranded, with ferrule														

Safety instruction!

Comments on hardware



- Do not connect capacitive or inductive loads!
- Outputs which are switched off are not electrically isolated from the mains; therefore do not disconnect them! When connecting an actuator drive, disconnect the device from the mains!
- The “N” terminals for outputs A1 to A6 are suitable only for connection to the actuator drives and should not be used for looping through to other devices! Looping through can cause damage to the device!

Connection diagram and control elements:

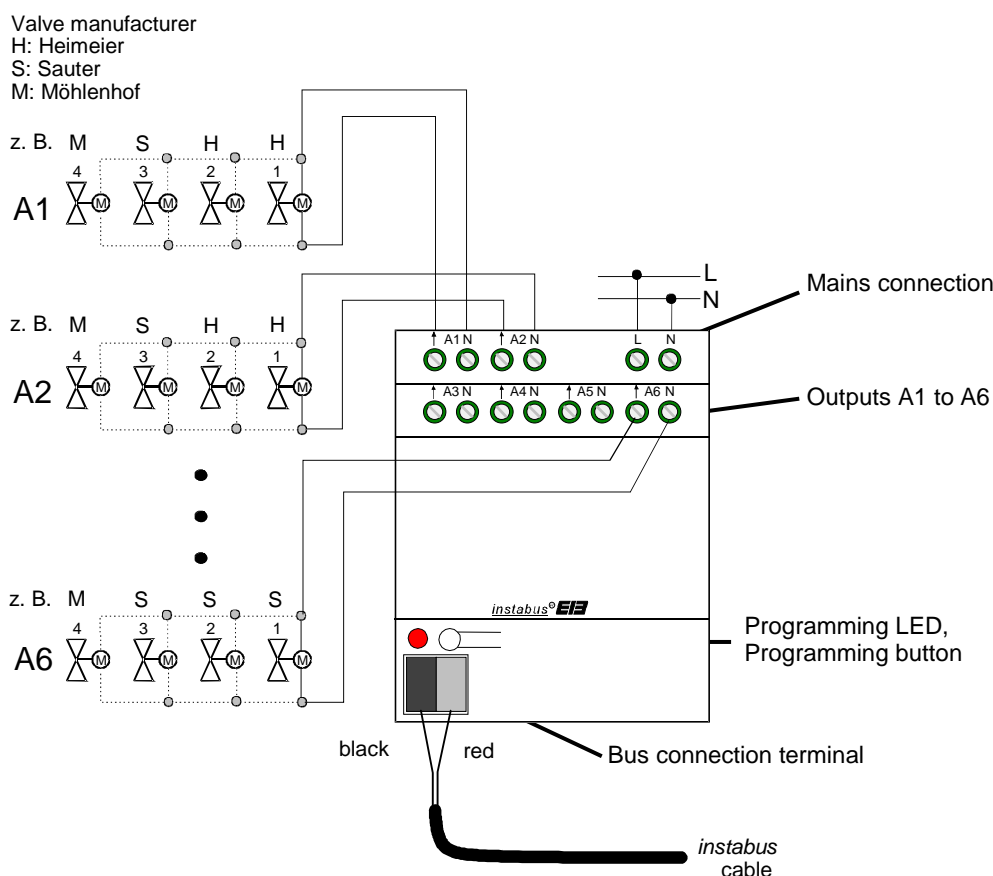

Note:

The outputs never switch simultaneously, but their switching is always staggered by 0.5 s, so that no overload is reported on switching (inrush current too large).

Each output can be connected to up to four control valves of different manufacturers (e. g. Heimeier, Sauter, Möhlenhoff) in any combination, even if the valves have different load characteristics.

So that no triggering of overload sensing due to the total inrush current can arise, even when all the outputs in one output group are switched, their switching is always staggered by 0.5 s (see “Short circuit / Overload” – “Test cycle / Combined Overload” on page 18”)

in any circumstance of a certain combination of types of load in an output channel, the loads connected to an output group should be equally mixed.

Example:

output 1: 2 x Heimeier, 1 x Sauter, 1 x Möhlenhoff
output 2: 2 x Heimeier, 1 x Sauter, 1 x Möhlenhoff
output 3: 2 x Heimeier, 1 x Sauter, 1 x Möhlenhoff

output 4: 3 x Sauter, 1 x Möhlenhoff
output 5: 3 x Sauter, 1 x Möhlenhoff
output 6: 3 x Sauter, 1 x Möhlenhoff

Application:		Switching PWM 206701		
Executable from screen version:	1.2			
Number of addresses (max.):	29	Dynamic table management	Yes <input checked="" type="checkbox"/>	No <input type="checkbox"/>
Number of assignments (max.):	29	Maximum table length	58	
Communication objects:	29			
Control variables:				
Object	Object name	Function	Type	Flag
<input type="checkbox"/> ← 0 - 5	Manipulated variable output 1 - 6	Input	1 bit ***	C, W, (R) *
<input type="checkbox"/> ← 0 - 5	Manipulated variable output 1 - 6	Input	1 byte ***	C, W, (R) *
Status of manipulated variables:				
Object name	Object name	Function	Type	Flag
<input type="checkbox"/> 6 - 11	Manipulated variable output 1 - 6	Status	1 bit ***	C, T, (R) **
<input type="checkbox"/> → 6 - 11	Manipulated variable output 1 - 6	Status	1 bit ***	C, R **
<input type="checkbox"/> 6 - 11	Manipulated variable output 1 - 6	Status	1 byte ***	C, T, (R) **
<input type="checkbox"/> → 6 - 11	Manipulated variable output 1 - 6	Status	1 byte ***	C, R **
Other functions:				
Object	Object name	Function	Type	Flag
<input type="checkbox"/> ← 12 - 17	Forced position output 1 - 6	Input	1 bit	C, W, (R) *
<input type="checkbox"/> 18 - 23	Output 1 - 6	Overload / short circuit	1 bit	C, T, (R) *
<input type="checkbox"/> 24	Power failure	Alarm message	1 bit	C, T, (R) *
<input type="checkbox"/> 25	All valves are closed	Status valves	1 bit	C, T, (R) *
<input type="checkbox"/> 26	Cyclical monitoring of manipulated variables	Alarm message	1 bit	C, T, (R) *
<input type="checkbox"/> ← 27	Summer / winter mode	Switch-over	1 bit	C, W, (R) *
<input type="checkbox"/> 28	Largest manipulated variable of all outputs	Max. value	1 byte	C, T, (R) *
<p>*: The current object status can be read for objects marked with (R) (set Read flag!).</p> <p>** : Depending on the general parameter "Status of the valve setting transmitter" the status of a manipulated variable is transmitted automatically if it is changed (T flag set) or it is transmitted only in response to a read request as a response to the read telegram (R flag set).</p> <p>***: The object size (1 bit or 1 byte) of the manipulated variable object and of the status manipulated variable object are dependent on the parameter "Type of manipulated variable" for each output.</p>				

Object description

0 - 5	Manipulated variable:	1 bit object for receiving manipulated variable telegrams (ON, OFF)
0 - 5	Manipulated variable:	1 byte object for receiving manipulated variable telegrams (0 – 255)
6 - 11	Status of control variable:	1 bit object for transmitting or reading status telegrams for manipulated variable (ON, OFF)
6 - 11	Status of manipulated variable:	1 byte object for transmitting or reading status telegrams for manipulated variable (0 – 255)
12 - 17	Forced position:	1 bit object for forced position of programmable outputs (“1” = forced position active / “0” = forced position inactive).
18 - 23	Overload / Short circuit:	1 bit object for overload / short circuit message of an output on the bus. The object remains active (polarity programmable) until the overload / short circuit has been rectified. When resetting an overload / short circuit message, disconnect the device from the mains! Only when mains power is restored will the overload / short circuit message be cancelled.
24	Alarm message:	1 bit object for reporting a mains power failure on the bus (polarity programmable).
25	Status of valves:	1 bit object indicating that all manipulated variables are “OFF” / “0” and thus all are valves closed (polarity programmable).
26	Alarm message:	1 bit object for reporting that manipulated variable programmable outputs are missing within the monitoring time and that back-up mode has been activated for the outputs concerned (polarity programmable).
27	Switch-over:	1 bit object for changeover between summer and winter mode (Polarity programmable).
28	Largest manipulated variable of all outputs:	1 byte object for feeding back the largest value stored in the actuator 1 byte manipulated variable for an output

Software Functionality

- 6 mutually independent outputs, which can be activated optionally by a 1 bit or a 1 byte manipulated variable.
- If the manipulated variable is 1 byte, the outputs are activated by pulse width modulation (PWM). The cycle time of the output signals is generally programmable.
- Status feedback (1 bit / 1 byte) available for each output automatically or on read request
- Valve activation (open when deenergised / closed) programmable for each output
- Summer or winter mode can be set by an object; polarity programmable
- Cyclic monitoring of the manipulated variable of each output on the basis of a generally programmable monitoring time configurable for all outputs. If a manipulated variable telegram is missing within the set monitoring time, the output affected reverts to back-up mode and an object transmits an alarm message on the bus (polarity programmable).
- Each output can be locked into a forced position. Different values can be programmed for summer and winter mode.
- Behaviour on bus power restoration separately configurable for each output
Setting options: “Valve closes”, “Valve opens”, “Forced position”, “Emergency mode”, “No response” (only on bus power failure).
- Overload / short circuit reporting by a separate object for each output (polarity programmable).
- Mains failure message can be transmitted by an object (polarity programmable)
- If the manipulated variables for all valves are “OFF” or “0”, a “Collective message” can be transmitted by an object (polarity programmable). This indicates that all valves are closed.
- The size of the 1 byte manipulated variable for an output held in the actuator can be transmitted by a separate object on the bus.

Functional Description

Overview

1. Actuating the outputs / pulse width modulation (PWM)

- 1.1 Manipulated variable 1 bit (switching)
- 1.2 Manipulated variable 1 byte (continuous)
 - 1.2.1 Manipulated variable adaptation
 - 1.2.2 Cycle time

2. Operating conditions

- 2.1 Normal mode
- 2.2 Forced position
- 2.3 Emergency mode
- 2.4 Short circuit / overload
 - 2.4.1 Detection of an overload / short circuit
 - 2.4.2 Test cycle
 - 2.4.3 Resetting deactivated outputs / transmitting bus telegrams "Message overload / short circuit"
 - 2.4.4. Examples of overload / short circuit detection

3. Monitoring

- 3.1 Mains power failure message
- 3.2 Cyclic monitoring of manipulated variables

4. Behaviour on bus power failure / bus power restoration

5. Status feedback

- 5.1 Status objects
- 5.2 Status object "All valves closed"
- 5.3 Feedback "Largest manipulated variable of all outputs"

6. Valve protection

7. Operating modes

1. Actuating the outputs / pulse width modulation (PWM)

All outputs can be activated independently of each other either by a 1 bit telegram (switching) or a 1 byte telegram (continuous). These telegrams can in both cases be sent to the actuator for instance by an EIB room thermostat. The controller determines the room temperature and generates the manipulated variable telegram based on a control algorithm.

Note that the actuator itself has no temperature control function!

1.1 Manipulated variable 1 bit (switching)

In normal mode with a 1 bit manipulated variable the switching telegram received by the object "Output X" is passed directly to the respective output of the actuator on the basis of the parameter "Mode of operation of valve / valve drive combination".

- Thus on receipt of an "ON" telegram the valve will be fully opened (output energised and "Combination valve / actuator drive direction" = "Current-free closed" / output not energised and "Mode of operation of valve / valve drive combination" = "Current-free open").
- The valve will be fully closed on receipt of an "OFF" telegram (output not energised and "Mode of operation of valve / valve drive combination" = "Current-free closed" / output energised and "Mode of operation of valve / valve drive combination" = "Current-free open").

When forced position is active because of an active emergency mode or a bus power failure / restoration a continuous setpoint (0 % to 100 % in 10 % steps) can be programmed and activated even with a 1 bit manipulated variable. In this case the setpoint is determined by pulse width modulation on the basis of the parameter "Cycle time" at the respective output (see "Manipulated variable1 byte").

1.2 Manipulated variable 1 byte (continuous)

In normal mode a 1 byte manipulated variable received by the object "Output X" is converted by the actuator into an equivalent pulse width modulated switching signal at the outputs. The average output signal resulting from this modulation is a measure for the valve setting of the control valve on the basis of the cycle time set in the actuator and is thus a reference for the room temperature setting.

A change in the average and thus a change in the heating power is achieved by changing the duty cycle of the input and output switching impulses of the output signal. The duty cycle is constantly adjusted by the actuator depending on the manipulated variable (normal mode) / activated manipulated variable (positive operation, normal mode, bus power failure / restoration) received.

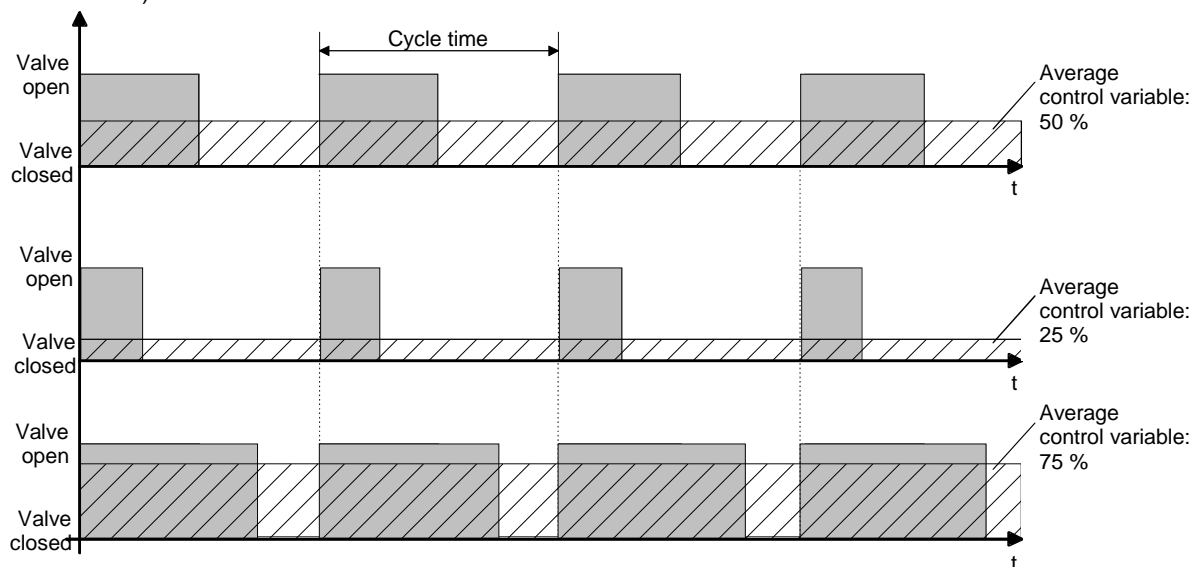

Based on the parameter "Mode of operation of valve / valve drive combination" for each output, the respective output is energised or not energised depending on the valve setting to be achieved.

If the drive is "Current-free open", the duty cycle is automatically inverted. There is therefore no undesirable shift in the average based on the type of valve used.

Example: manipulated variable: 60 % →
 - duty cycle "Current-free closed": 60 % on, 40 % off,
 - duty cycle "Current-free open": 40 % on, 60 % off

1.2.1 Manipulated variable adaptation

Control circuits are often subjected to step changes in the setpoint value (e. g. frost protection, night time mode, etc.) or temporary interference (e. g. measurement value fluctuations due to short periods during which windows or doors near to the sensor are opened).

So that the system can respond by adjusting the duty cycle for the manipulated variable as quickly and accurately as possible in these cases even when the cycle time is set to a longer setting, without any deterioration in the response time of the control loop, the actuator has a special procedure for continuous adaptation of the manipulated variable.

The following cases are catered for:

Case 1:

A change in the manipulated variable e. g. from 80 % to 30 % during the opening phase of the valve.

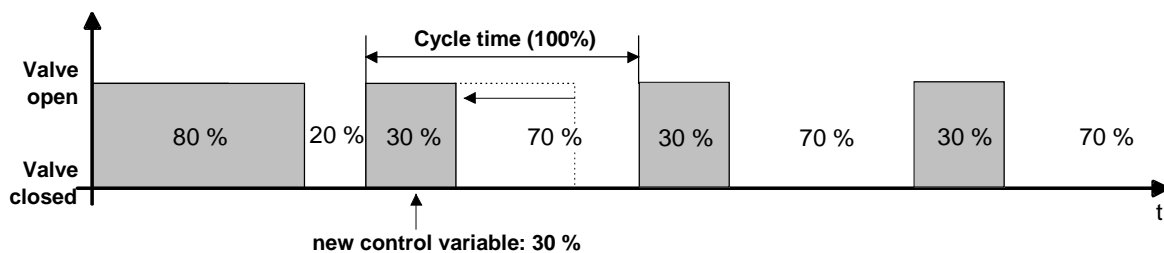

Before receipt of the new manipulated variable (30 %) the old setpoint (80 %) was active. The new manipulated variable is received during the opening phase of the valve. At this point in time the actuator recognises that it is still possible to cut short the opening phase so that it corresponds to the new manipulated variable (30 %). The cycle time is unchanged by this procedure.

The new duty cycle is established immediately on receipt of the new manipulated variable.

Case 2:

A change in the manipulated variable e. g. from 80 % to 30 % during the closing phase of the valve.

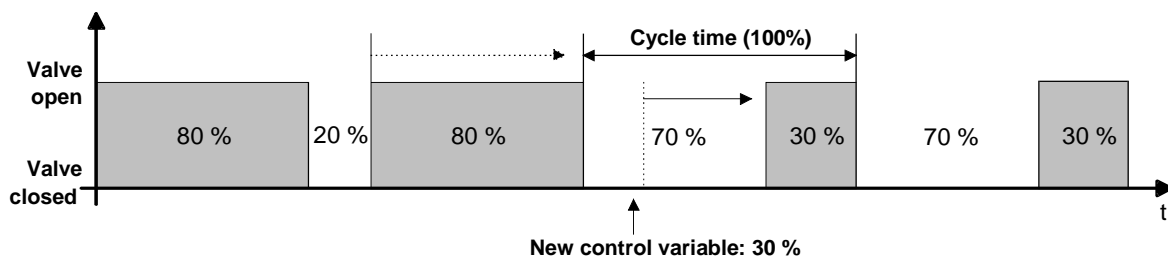

Before receipt of the new manipulated variable (30 %) the old setpoint (80 %) was active. The new manipulated variable is received during the closing phase of the valve. At this point in time the actuator recognises that it is still possible to cut short the closing phase so that it corresponds to the new manipulated variable (30 %). The cycle time remains unchanged, the starting time of the period is nevertheless automatically delayed.

The new duty cycle is established immediately on receipt of the new manipulated variable.

Case 3:

A change in the manipulated variable e. g. from 80 % to 30 % during the opening phase of the valve (opening phase already 30 % completed):

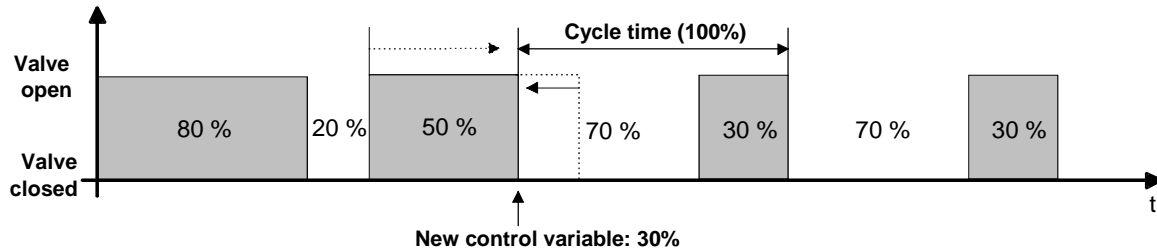

Before receipt of the new manipulated variable (30 %) the old setpoint (80 %) was active. The new manipulated variable is received during the opening phase of the valve. At this point in time the actuator recognises that it is necessary immediately to cut short the opening phase and to close the valve, since the duty cycle of the new manipulated variable (30 %) has already been exceeded. The cycle time remains unchanged, the starting time of the period is nevertheless automatically delayed in order to establish the new duty cycle as soon as possible. The new duty cycle is established immediately on receipt of the new manipulated variable.

Case 4:

A change in the manipulated variable e. g. from 30 % to 80 % during the opening phase of the valve:

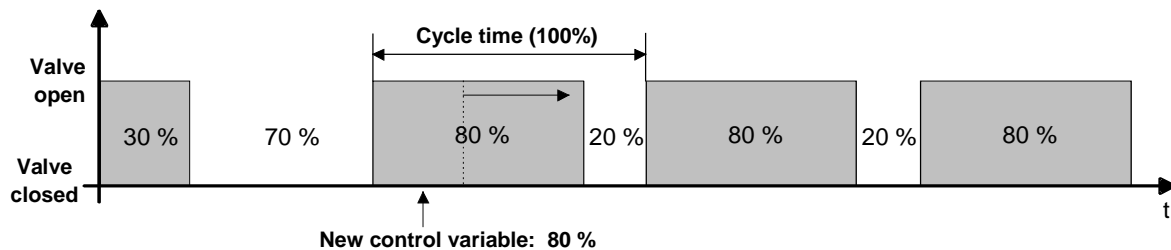

Before receipt of the new manipulated variable (80 %) the old setpoint (30 %) was active. The new manipulated variable is received during the opening phase of the valve. At this point in time the actuator recognises that it is still possible to extend the opening phase so that it corresponds to the new manipulated variable (80 %). The cycle time is unchanged by this procedure.

The new duty cycle is established immediately on receipt of the new manipulated variable.

Case 5:

A change in the manipulated variable e. g. from 30 % to 80 % during the closing phase of the valve:

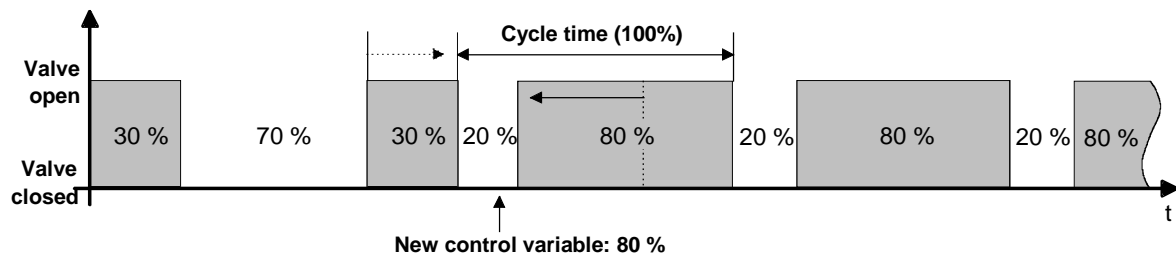

Before receipt of the new manipulated variable (80 %) the old setpoint (30 %) was active. The new manipulated variable is received during the closing phase of the valve. At this point in time the actuator recognises that it is still possible to cut short the closing phase so that it corresponds to the new manipulated variable (80 %). The cycle time remains unchanged, the starting time of the period is nevertheless automatically delayed in order to establish the new duty cycle as soon as possible.

The new duty cycle is established immediately on receipt of the new manipulated variable.

Case 6:

A change in the manipulated variable e. g. from 30 % to 80 % during the closing phase of the valve (closing phase too long):

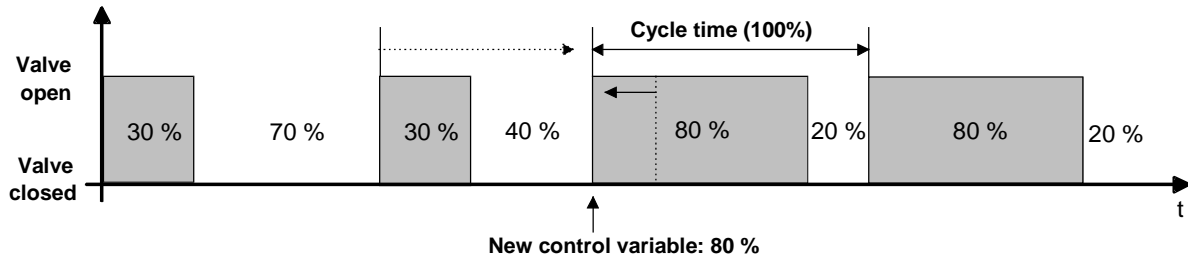

Before receipt of the new manipulated variable (80 %) the old setpoint (30 %) was active. The new manipulated variable is received during the closing phase of the valve. At this point in time the actuator recognises that it is necessary immediately to cut short the opening phase and to open the valve so that it corresponds to the duty cycle of the new manipulated variable (80 %). The cycle time remains unchanged, the starting time of the period is nevertheless automatically delayed in order to establish the new duty cycle as soon as possible.

The new duty cycle is established immediately on receipt of the new manipulated variable.

2. Operating conditions

Each output of the actuator can prevail under different operating conditions, which depending on the circumstances can be activated by separate objects. The various operating conditions are indicated below.

2.1 Normal mode

The 1 bit or 1 byte manipulated variables received at the inputs are passed directly to the respective outputs as switching commands or as pulse width modulations. If the parameter "Mode of operation of valve / valve drive combination" so requires, the manipulated variables are inverted.

2.2 Forced position

By means of the parameter "Forced position?" for each output of the actuator a forced position function can be enabled ("Yes") or disabled ("No"). Forced position in the enabled state is activated by the assigned forced position object, for which the object polarity is programmable.

For forced position of an output a continuous forced value (0 % to 100 % in 10 % steps) can be programmed in the actuator, which is adopted as the manipulated variable setpoint if forced position is activated. The forced value settings can be different for summer mode and winter mode.

A continuous forced value for forced position can be set even for a 1 bit manipulated variable; in this case a pulse width modulation is set at the output.

While forced position is active, manipulated variables that are received are saved. The last manipulated variable received is then adopted as the manipulated variable setpoint after quitting the forced position (changeover to normal mode). A forced position function activated by the forced position objects before a bus power failure is always deactivated after bus power restoration.

At bus power failure and after bus power restoration the positive value can be adopted as the manipulated variable setpoint, if so programmed. Therefore even when forced position is not enabled the positive value(s) for summer mode and winter mode are visible and can be set.

2.3 Emergency mode

If manipulated variables are cyclically monitored, when new values arise (see "3.2 Cyclic monitoring of manipulated variables") after a value is missed emergency mode is activated. In addition the emergency mode can be activated on bus power failure or restoration. The resulting assignments of the 6 outputs for emergency mode are shown on the parameter card "emergency mode".

For the emergency mode of an output the actuator a continuous emergency mode value (0 % to 100 % in 10 % steps) can generally be programmed on the parameter card "emergency mode"; on activation of emergency mode this is adopted as the manipulated variable setpoint. The emergency mode value settings can be different for summer mode and winter mode.

A continuous forced value for emergency mode can be set even for a 1 bit manipulated variable; in this case a pulse width modulation is set at the output.

Emergency mode will be terminated as soon as a manipulated variable telegram is received by the manipulated variable object of the respective output (changeover to normal mode).

A forced position has a higher priority than a emergency mode. If prior to the emergency mode a forced position was active or during the emergency mode a forced position was activated, the actuator adopts the forced value as the manipulated variable setpoint for the respective output. After bus power restoration the emergency mode value can, if so programmed, be adopted as the manipulated variable setpoint, even if prior to the bus power failure a forced position was active.

2.4 Short circuit / overload

The actuator has a short circuit / overload detection facility, whereby after a detection time several short-circuited / overloaded outputs can be deactivated. The short circuit / overload detection is always active whenever an output channel is in the switched on state (output energised). In addition the parameter "Object 'Overload/Short circuit'?" can be separately enabled for each output, determining whether a short circuit / overload message is transmitted by an object on the bus.

2.4.1 Detection of an overload / short circuit

The short circuit / overload detection is performed essentially in two output groups. Outputs 1 to 3 form one group, and outputs 4 to 6 the other.

In the event of a fault the actuator recognises an overload / short circuit initially exclusively at the level of a group.

Important note:

In the event of a fault the output groups do exert an influence on each other, depending on the timing, duration and size of the overload or short circuit. So for example a 'hard' short circuit at one output may first appear as an overload / short circuit detection in both groups, although the other outputs are obviously not affected.

In the case of a 'soft' overload at one output on the other hand it is to be expected that detection will occur only in the immediately affected output group.

For this reason an overload / short circuit detection may not immediately be definitely reducible to the outputs actually affected. **The actuator therefore conducts a special test cycle in this connection, which ensures reliable detection of the one or more overloaded output channels.** Only when the overloaded / short-circuited output had been precisely determined can the overload / short circuit messages be transmitted on the bus.

After a fault detection in one group, all outputs in that group or in both groups (depending on timing, duration and size of the overload) are immediately deactivated for 6 minutes (shut-down delay phase / outputs not energised). In this time the fault detection switching resets itself. The unaffected outputs of the other output group may in some circumstances at first continue to operate 'normally'.

If during a 6 minutes shut-down delay phase a fault case is detected in the other output group, the collective delay phase is extended for a further 6 minutes.

2.4.2 Test cycle

Only in a following test cycle are **all** 6 outputs of the actuator deactivated.

There follows a step-by-step timed switching on and deactivation of each output in the respective group(s), to determine which outputs are overloaded / short-circuited and thus should be switched off due to a fault.

In the case of a 'soft' overload at for instance only one output within a test cycle it may occur that during the individual testing of the outputs during the switching-on phase no overload is detected, because the overload is too slight. It therefore may be necessary to start several test cycles before the overloaded output is definitely detected.

Each output group is provided with a counter, which records the number of test cycles started so far for the group. Each time a test cycle fails to identify any output channel as definitely overloaded or short-circuited, the counter is incremented by one. If a further fault case arises in an output group that has already been tested without success for overloads / short circuits (counter > "0"), in the new test cycle the outputs are energised with an extended application time. The count is stored exclusively within the device and cannot be read.

In the first test cycle the application time is 1 second, in the second cycle 10 seconds, in the third cycle 1 minute and in the fourth cycle 4 minutes.

A combined overload occurs when several 'soft' overloads at several outputs in some circumstances combine to generate a 'harder' combined overload. In the case of a combined overload it can occur that even after four test cycles no output can be definitely identified as overloaded. In this case after the fourth cycle the actuator deactivates individual output channels of an output group in turn, until there is no longer an overload (see "The test cycle in detail").

The test cycle in detail:

- 1 - An overload or short circuit may be detected in one group or in both output groups (depending on timing, duration and size of the overload). The actuator deactivates the outputs of the group(s) concerned. The shut-down delay phase (6 minutes) is started. The unaffected outputs of the other output group may in some circumstances at first continue to operate 'normally'. If within the shut-down delay phase a test cycle is already running in the other output group, the actuator waits until the other group has finished being tested (shut-down delay phase \geq 6 minutes),
- 2 - **All** outputs of the actuator are switched off (outputs not energised),
- 3 - The first output of the affected group(s) (output 1 or output 4) switches on for approx. 1 second, unless that output had already been deactivated by a previous test cycle. If the output has already been deactivated, the actuator switches the following output on (output 2 or output 4, etc.),
 - 3 a If within the application time no overload or short circuit is detected, because the overload / short circuit is at another output or is too slight ('soft' overload), the output is switched off again. Continue with step 4,
 - 3 b- If an overload or short circuit is detected at the output that is tested, this output channel is immediately and positively switched off. The output is deactivated. A shut-down delay phase of 6 minutes is started at the terminal, during which time the fault detection switching is reset. The affected output group remains switched off throughout this time. The other group continues to operate 'normally', providing it had not previously generated a short circuit / overload signal and so is not included in the test cycle. Continue with step 4,
- 4 - **All** outputs of the actuator are switched off again. The output test started under step 3 continues by output testing in succession the next outputs of the affected group(s) that have not already been deactivated, at intervals of approx. 4 seconds, until the last output of the group / of both groups has been processed,
- 5 - The test cycle is only finally ended when eventually all the outputs of one group / of both groups has been processed,

- 5 a - The outputs detected as overloaded / short-circuited during the test cycle of the group(s) now remain deactivated and cannot be switched on again until a reset is performed (see "2.4.3 Resetting deactivated outputs"). The test cycle counter is then cleared down. All unaffected outputs revert to 'normal' activation,
- 5 b - If during the test cycle no output is detected as overloaded or short-circuited (probably a 'softer' overload), the test cycle counter for this group(s) is incremented, so that in the next cycle all affected outputs are tested with an extended application time, so as to be able to detect even softer overloads.

Exception: If the previous test cycle had already been the fourth cycle without detecting a fault, the actuator assumes that this is a case of a combined overload on several outputs. In this case the actuator automatically deactivates with overriding priority one output of the affected group(s) (output 3 and/or output 6). This ensures that in the event of regular detection of a fault the test cycles counter is cleared down and the next cycle thus starts again with a 1 s application time. If the following 4 test cycles are run through without any outputs being detected as overloaded or short-circuited during the individual testing, the actuator once again assumes a combined overload and automatically permanently deactivates the next outputs of the group(s) (first output 2 and/or output 5, then after four further cycles output 1 and/or output 4),

Note:

Actuator drives for rooms liable to frost should be connected to outputs 1 and 4, since these outputs are the last to be deactivated on combined overload.

- 6 - All the outputs not deactivated in the test cycles continue to operate as 'normal'.

2.4.3 Resetting deactivated outputs / transmitting bus telegrams "Message overload / short circuit"

Message telegrams are only transmitted for the outputs that were deactivated with overriding priority after detection of a fault or after a combined overload in the test cycle. A pre-requirement is that the object "Overload / Short circuit" (polarity programmable) is enabled in the ETS.

To reset a short circuit message or to restart one or more deactivated outputs the mains power supply to the actuator must be switched off. In this case immediately after a mains power failure a mains power failure telegram can be transmitted on the bus, if this is enabled (see "3.1 Mains power failure message"). A short circuit message is not reset by this means.

A short circuit message is reset only when the mains power is restored and in addition the mains power failure message is reset (in both cases telegrams are transmitted on the bus). On connection, the updated manipulated variable setpoint of the output that had previously been short-circuited will be implemented.

If on mains power restoration the outputs are still overloaded or short circuited, the actuator detects the overload or short circuit and starts the test cycle once again as described.

An active short circuit message (message not yet reset by mains power restoration) is not lost on bus power failure. An overload /short circuit message is saved in non-volatile form for each output, so that on bus power restoration it can be evaluated whether the short circuit present at bus power failure has since been rectified or is still present.

The actuator transmits an inverse reset message on the bus (no short circuit) after bus power restoration if during the bus power failure the short circuit previously reported had been rectified and also the mains power had been switched off and restored again. If the short circuit has not been rectified, no new message will be transmitted on the bus after bus power restoration. The message is reset only when the mains power is switched off and on again.

Notes:

Even an output switched off by the bus (output not energised) can be energised during the overload / short circuit detection phase!

A fully open valve (open when deenergised) that is open due to a short circuit / overload is not included in the determination of the "largest manipulated variable".

Examples of overload /short circuit detection

Example 1: Fault case = 'hard' short circuit on output 4.

A 'hard' short circuit generates a short circuit / overload signal in both output groups. This generates the following procedure:

Test time	Outputs						Bus message						Comments
	1	2	3	4	5	6	1	2	3	4	5	6	
6min	0	0	0	0	0	0	-	-	-	-	-	-	If short circuit signal affects both groups!
1s	1	0	0	0	0	0	-	-	-	-	-	-	Check output 1 → No fault
1s	0	1	0	0	0	0	-	-	-	-	-	-	4 s later check output 2 → No fault
1s	0	0	1	0	0	0	-	-	-	-	-	-	4 s later check output 3 → No fault
<1s	0	0	0	1	0	0	-	-	-	T	-	-	4 s later check output 4 → Short circuit
6min	0	0	0	0	0	0	-	-	-	-	-	-	Shut-down delay phase. Short circuit message
1s	0	0	0	0	1	0	-	-	-	-	-	-	Check output 5 → No fault
1s	0	0	0	0	0	1	-	-	-	-	-	-	4 s later check output 6 → No fault
---	N	N	N	0	N	N	-	-	-	-	-	-	4 s later output 4 remains deactivated! All other outputs continue to function 'normally'!

"1"/ "0" = output energised/not energised / "N" = 'Normal' mode of the output / "T" = active overload / short circuit message (if enabled)

At the next fault detection

in group 1-3: test application time: 10 s

in group 4-6: test application time: 1 s

Example 2: fault case = 'soft' overload on output 2.

The overload is so soft that an application time of 1 second does not lead to fault detection. With a 'soft' overload it is to be expected that the overload / short circuit signal can be detected only in the output group immediately affected (here: outputs 1 to 3). This generates the following procedure:

Test time	Outputs						Bus message						Comments
	1	2	3	4	5	6	1	2	3	4	5	6	
6min	0	0	0	N	N	N	-	-	-	-	-	-	If overload affects only one group!
1s	1	0	0	0	0	0	-	-	-	-	-	-	Check output 1 → no fault.
1s	0	1	0	0	0	0	-	-	-	-	-	-	4 s later check output 2 → No fault
1s	0	0	1	0	0	0	-	-	-	-	-	-	4 s later check output 3 → No fault
---	N	N	N	N	N	N	-	-	-	-	-	-	4 s later: all other outputs functioning 'normally'.

"1"/ "0" = output energised/not energised / "N" = 'Normal' mode of the output / "T" = active overload / short circuit message (if enabled)

At the next fault detection

in group 1-3: test application time: 10 s

in group 4-6: test application time: 1 s

it is to be expected that in 'Normal mode' the overload can be detected in the output group immediately preceding the output group affected.

Test time	Outputs						Bus message						Comments
	1	2	3	4	5	6	1	2	3	4	5	6	
6min	0	0	0	N	N	N	-	-	-	-	-	-	If overload affects only one group!
10s	1	0	0	0	0	0	-	-	-	-	-	-	Check output 1 → no fault.
<10s	0	1	0	0	0	0	-	T	-	-	-	-	4 s later check output 2 → Overload
6min	0	0	0	N	N	N	-	-	-	-	-	-	Shut-down delay phase. Overload alarm
10s	0	0	1	0	0	0	-	-	-	-	-	-	4 s later check output 3 → No fault
---	N	0	N	N	N	N	-	-	-	-	-	-	4 s later output 2 remains deactivated! All other outputs continue to function 'normally'!

At the next fault detection

in group 1-3: test application time: 1 s
in group 4-6: test application time: 1 s

Example 3: fault case = Combined Overload in output group “Output 1 to 3”.

The overload of individual outputs is so soft that during the test cycles up to a test application time of 4 minutes no output could be definitely identified as overloaded or short-circuited. This generates the following procedure:

Test time	Outputs						Bus message						Comments
	1	2	3	4	5	6	1	2	3	4	5	6	
6min	0	0	0	N	N	N	-	-	-	-	-	-	If overload affects only one group!
1s	1	0	0	0	0	0	-	-	-	-	-	-	Check output 1 → no fault.
1s	0	1	0	0	0	0	-	-	-	-	-	-	4 s later check output 2 → No fault
1s	0	0	1	0	0	0	-	-	-	-	-	-	4 s later check output 3 → No fault
---	N	N	N	N	N	N	-	-	-	-	-	-	4 s later: all other outputs functioning 'normally'.

“1”/“0” = output energised/not energised / “N” = 'Normal' mode of the output / “T” = active overload / short circuit message (if enabled)

At the next fault detection

in group 1-3: test application time: 10 s
in group 4-6: test application time: 1 s

it is to be expected that in 'Normal mode' the overload can be detected in the output group immediately preceding the output group affected.

Test time	Outputs						Bus message						Comments
	1	2	3	4	5	6	1	2	3	4	5	6	
6min	0	0	0	N	N	N	-	-	-	-	-	-	If overload affects only one group!
10s	1	0	0	0	0	0	-	-	-	-	-	-	Check output 1 → no fault.
10s	0	1	0	0	0	0	-	-	-	-	-	-	4 s later check output 2 → No fault
10s	0	0	1	0	0	0	-	-	-	-	-	-	4 s later check output 3 → No fault
---	N	N	N	N	N	N	-	-	-	-	-	-	4 s later: all other outputs functioning 'normally'.

At the next fault detection

in group 1-3: test application time: 1 min.
in group 4-6: test application time: 1 s

it is to be expected that in 'Normal mode' the overload can be detected in the output group immediately preceding the output group affected.

Test time	Outputs						Bus message						Comments
	1	2	3	4	5	6	1	2	3	4	5	6	
6min	0	0	0	N	N	N	-	-	-	-	-	-	If overload affects only one group!
1min	1	0	0	0	0	0	-	-	-	-	-	-	Check output 1 → no fault.
1min	0	1	0	0	0	0	-	-	-	-	-	-	4 s later check output 2 → No fault
1min	0	0	1	0	0	0	-	-	-	-	-	-	4 s later check output 3 → No fault
---	N	N	N	N	N	N	-	-	-	-	-	-	4 s later: all other outputs functioning 'normally'.

At the next fault detection in group 1-3: test application time: 4 min.
in group 4-6: test application time: 1 s

it is to be expected that in 'Normal mode' the overload can be detected in the output group immediately preceding the output group affected.

Test time	Outputs						Bus message						Comments
	1	2	3	4	5	6	1	2	3	4	5	6	
6min	0	0	0	N	N	N	-	-	-	-	-	-	If overload affects only one group!
4min	1	0	0	0	0	0	-	-	-	-	-	-	Check output 1 → no fault.
4min	0	1	0	0	0	0	-	-	-	-	-	-	4 s later check output 2 → No fault
4min	0	0	1	0	0	0	-	-	-	-	-	-	4 s later check output 3 → No fault
---	N	N	0	N	N	N	-	-	T	-	-	-	4 s later: output 3 is automatically deactivated with overriding priority! All other outputs continue to function 'normally'!

At the next fault detection in group 1-3: test application time: 1 s
in group 4-6: test application time: 1 s

3. Monitoring

The functions described below are available to ensure the uninterrupted operation of the actuator.

3.1 Mains power failure message

For activation of the actuator drives, the actuator requires mains voltage at the outputs. If this is not present, the drive will take up its normal position (open / closed when deenergised). So that a mains power failure does not pass unnoticed at the actuator, a mains power failure message can be transmitted on the bus by the object "Alarm message mains power failure".

This alarm message can be enabled by setting the parameter "Alarm message on mains power failure? =Yes" on the parameter card "monitoring". If the function is enabled, the parameter "Polarity of object 'mains power failure'" will be visible, by which it can be determined which telegram polarity the mains power failure telegram should have (telegram on mains power failure = "1" or "0").

If the mains power fails, the mains power failure telegram will be transmitted immediately. The actuator only retracts the alarm message when the mains power is restored, and transmits the inverse reset telegram (no mains power failure).

After bus power restoration the current mains power status (mains power present / not present) is always transmitted.

A fully open valve (open when deenergised) that is open due to a mains power failure is not included in the determination of the "largest manipulated variable".

3.2 Cyclic monitoring of manipulated variables

The actuator is in the position to monitor the manipulated variable telegrams that it receives for instance from a room thermostat (1 bit or 1 byte). This monitoring can be enabled by setting the parameter "Enable monitoring of the manipulated variables? = Yes" on the parameter card "monitoring". If it is enabled, the object "Alarm message cyclic monitoring of manipulated variables" is visible, in which case if any manipulated variable telegrams are missing an alarm message can be transmitted. The polarity of this object can be programmed by the parameter "Polarity of object 'Cyclic monitoring of manipulated variables'" on the parameter card "monitoring".

If the function is enabled, each output can be separately assigned for monitoring its manipulated variable. The assignment is determined by the parameter "Cyclic monitoring of the manipulated variable = Enabled" on the parameter card "output X". As soon as an output is assigned by the monitoring, the actuator within a programmable window of time tests the manipulated variable object(s) for receipt of telegrams. The window of time is generally programmed for all outputs by the parameter "Monitoring time for cyclic monitoring of the manipulated variables" on the parameter card "monitoring". The time set here should match the time for cyclic transmission of manipulated variables by the controller. To ensure that at least one telegram is received within the monitoring time, the actuator automatically adds an offset of approx. 33 seconds to the programmed time.

As soon as a manipulated variable telegram is found to be missing at the monitored output, the actuator transmits a single alarm message by the object "Alarm message cyclic monitoring of manipulated variables" and activates emergency mode for the affected output(s) (see "2.3 Emergency mode", page 17).

The actuator retracts the alarm message for cyclic monitoring only when manipulated variable telegrams have been received again for all monitored outputs. The emergency mode of an output is deactivated as soon as manipulated variable telegrams have been received again for that output.

Note:

Note that the cyclic monitoring is active even during operating modes other than normal mode (e. g. positive operation, mains power failure, overload / short circuit)!

4. Behaviour on bus power failure / bus power restoration

The behaviour of the actuator at bus power failure and after bus power restoration is separately programmable for each output.

Thus a drive can be set either to open or to close at bus power failure / restoration. Depending on the parameter "Combination valve / actuator drive direction" the outputs are either energised or not energised, so that the programmed response occurs.

In addition there is the facility at bus power failure / restoration to activate the values for forced position or for emergency mode as manipulated variable setpoints. To do this the actuator accesses the programmed values for forced position (separately for each output) or for emergency mode (generally for all outputs) for the affected outputs. The values for summer mode and winter mode are distinguished here, if an operating mode changeover is enabled (see "7. Operating modes",). The forced position function or the emergency mode itself is not activated by this! With 1 bit manipulated variables the continuous value for forced position / emergency mode is set by a pulse width modulation at the outputs.

A forced position function activated by the forced position objects or a emergency mode activated before bus power failure is always deactivated after bus power restoration .

"No response" can also be programmed, but only for bus power failure, whereby the manipulated variable setpoint active before bus power failure for the respective outputs continues to be set at the outputs.

In addition, at bus power restoration, the current mains power status (mains power present / not present) and the status telegrams of the outputs, if automatic transmission is activated (see "5.1 Status objects" on this page), are transmitted.

The "Largest manipulated variable" (see "5.3 Feedback 'Largest manipulated variable'") is, if enabled, automatically transmitted after bus power restoration by the object "Max. value, largest manipulated variable of all outputs", if it is > "0".

After bus power restoration the status "All valves are closed" (see "5.2 Status object 'All valves are closed'") depending on the evaluation of all valve positions and of the parameter "Behaviour on bus power restoration", if enabled, is automatically transmitted to all outputs.

An active short circuit message (message not yet reset by mains power restoration) is not lost on bus power failure. A short circuit message is saved in non-volatile form for each output, so that on bus power restoration it can be evaluated whether the short circuit present at bus power failure has since been rectified or is still present. The actuator transmits an inverse reset message on the bus (no short circuit) after bus power restoration, if during the bus power failure the short circuit previously reported had been rectified and also the mains power had been switched off. If the short circuit has not been rectified, the message will only be reset when the mains power is switched off.

5. Status feedback

5.1 Status objects

For each output there exists a status object by which the current output manipulated variable in every operating status is automatically transmitted on the bus or can be read on request. The general parameter "Send status of the valve setting" determines the pattern for the status feedback. The parameter has the following setting options:

- "No status": the status feedback is fully deactivated. In this setting (default setting) the status objects are hidden.
- "On read request": the output status is only transmitted on receipt of an external read request from another bus device. In this setting the read flags ("R" flags) of the status object are pre-set.
- "At modification": the output status is automatically transmitted on a change in the output manipulated variable. In addition the status of all outputs is transmitted after bus power restoration.

The contents of the status object vary depending on the active operating status. The following tables give more details.

Manipulated variable1 byte:

Operating status	Content of manipulated variable object	Content of status object	Comments
Normal operation	Last external value	Manipulated variable setpoint (last external value)	---
Forced position	Last external value	Positive value	After the forced position the last external manipulated variable received is adopted and is written to the status object.
Emergency mode	Back-up value (until an external value is received)	Back-up value (see comment regarding positive value)	A forced position has a higher priority than a emergency mode. If before a emergency mode a forced position was active, the positive value appears in the status object. After the emergency mode the last external manipulated variable received is adopted and is written to the status object if no forced position is active.
Short circuit / overload	Last external value	"255" for "current-free open"; "0" for "current-free closed"	The output is deactivated. A fully open valve (open when deenergised) that is open due to a short circuit / overload is not included in the determination of the "largest manipulated variable" (see "5.3 Feedback" "Largest manipulated variable", page 27)!
Power failure	Last external value	"255" for "current-free open"; "0" for "current-free closed"	A fully open valve (open when deenergised) that is open due to a mains power failure is not included in the determination of the "largest manipulated variable" (see "5.3 Feedback" "Largest manipulated variable", page 27)!
Bus power - restoration	"0" (waits for an external value)	Manipulated variablesetpoint according to the parameter "behaviour on bus power - restoration"	---
Anti-seize routine	Last external value	no influence!	---

Manipulated variable¹ bit:

Operating status	Content of manipulated variable object	Content of status object	Comments
Normal operation	Last external value	Manipulated variable setpoint (last external value)	---
Compulsory Position	Last external value	Positive value "0" at 0 % "1" at > 0 %	After the forced position the last external manipulated variable received is adopted and is written to the status object.
Emergency mode	Back-up value "0" at 0 % "1" at > 0 % (until external value is received)	Back-up value "0" at 0 % "1" at > 0 % (see comment regarding positive value)	A forced position has a higher priority than a emergency mode. If before a emergency mode a forced position was active, the positive value appears in the status object. After the emergency mode the last external manipulated variable received is adopted and is written to the status object if no forced position is active.
Short circuit / overload	Last external value	"1" for "current-free open"; "0" for "current-free closed"	The output is deactivated.
Power failure	Last external value	"1" for "current-free open"; "0" for "current-free closed"	---
Bus power - restoration	"0" (waits for an external value)	Manipulated variable setpoint according to the parameter "behaviour on bus power restoration"	---
Anti-seize routine	Last external value	no influence!	---

5.2 Status object "All valves are closed"

To communicate to heating system controls (e. g. pump controls), that no heating energy is demanded, or for visualisation purposes, the actuator can transmit the information over the bus that all valves are closed.

To enable this status function, set the parameter "Status object 'All valves are closed'?" = "Enabled" on the parameter card "General". If all valves are closed (all manipulated variable setpoints = "0") a message in the form of a 1 bit telegram is transmitted by the object "Status of valves" with programmable polarity. The actuator retracts the message (inv. reset telegram) as soon as the manipulated variable setpoint of an output (1 bit or 1 byte) changes to a value > "0".

The status function is effective even for valves that are fully open (open when deenergised) or closed (closed when deenergised) due to short circuit / overload or mains power failure.

After bus power restoration, if the status function is enabled, the status "All valves are closed" is automatically transmitted to all outputs, depending on the evaluation of all valve positions and of the parameter "Behaviour on bus power restoration".

5.3 Feedback "Largest manipulated variable of all outputs"

For boilers with certain calorific outputs the information of the largest heating manipulated variable can be necessary to determine the optimum flow temperature of the heating circuit.

The actuator always determines the largest active 1 byte manipulated variable setpoint and can actively transmit this by a separate object "Max. value, largest manipulated variable of all outputs". This feedback function can be enabled by the parameter "Feedback of the 'largest manipulated variable'?" = "Enabled" on the parameter card "General".

The transmission is performed when the largest value changes, depending on the operating status (e. g. in normal mode, when a manipulated variable is received). After bus power restoration the largest manipulated variable is transmitted only if it is > "0".

Switching manipulated variables (1 bit) are not considered when determining the largest manipulated variable!

A fully open valve (open when deenergised / value = "255") that is open due to a short circuit / overload or mains power failure is not included in the determination of the "largest manipulated variable".

6. Valve protection

To prevent a valve that has not been activated for a long time becoming scaled up or seized, the actuator has an automatic anti-seize routine.

If the anti-seize routine is enabled by the parameter setting "Anti-seize routine" = "Yes" on the parameter card "General", then in a cycle of 6 days irrespective of the current operating status, the actuator energises all outputs simultaneously (switching staggered by approx. 0.5 seconds) for a duration of approx. 5 minutes. After this switch-on cycle the actuator deactivates all outputs for a further duration of approx. 5 minutes. This ensures that all valves, irrespective of whether they are open when deenergised or closed when deenergised, are more or less completely opened and closed and thus 'run through' their entire operating travel once.

In connection with the anti-seize routine the actuator activates the outputs again depending on the operating status.

An anti-seize routine always runs 'in the background', independently of the bus power, and is not reported on the bus.

After a mains power restoration approx. 6 days must pass before the first anti-seize routine is automatically performed.

7. Operating modes

So as to permit, depending on the time of year, different manipulated variable setpoints to be set for emergency mode and for positive operation, the actuator has available an operating mode changeover.

This allows the actuator to be changed over between summer mode and winter mode, using the 1 bit object "Changeover" (polarity configurable). Depending on the operating mode thereby activated, the value programmed for emergency mode or for forced position for summer mode and winter mode in each case is adopted as the manipulated variable setpoint.

The operating mode changeover can be enabled by setting the parameter "Changeover summer mode / winter mode" = "Yes" on the parameter card "General". After programming the actuator or after bus power restoration the parameter "Operating mode after commissioning" determines whether the operating mode previously set is adopted.

The operating mode can be changed over even when emergency mode or forced position is activated. In this case the value for that operating mode will be activated immediately after the changeover.

Parameter		
Description:	Values:	Commentary:
 General		
Valve protection	Yes No	To prevent a valve that has not been activated for a long time becoming scaled up or seized, the actuator has an automatic anti-seize routine. Anti-seize routine activated. Anti-seize routine deactivated.
Status object "All valves are closed"?	enabled disabled	To communicate to heating system controls (e. g. pump controls), that no heating energy is demanded, or for visualisation purposes, the actuator can transmit the information over the bus that all valves are closed. Status function "All valves are closed" enabled. Status function "All valves are closed" disabled.
Polarity of object "All valves are closed"	Object value when "All valves are closed" = 0 Object value when "All valves are closed" = 1	Determines the polarity of the object "Status of valves". <i>Only when "Status object 'All valves are closed'?" = "enabled"!</i>
Transmit status of the manipulated variables	No status Only on a read request At modification	For each output there exists a status object by which the current output manipulated variable in every operating status is automatically transmitted on the bus or can be read on request. The parameter determines the pattern for the status feedback. Status feedback is fully deactivated (status objects are hidden). The output status is only transmitted on receipt of an external read request from another bus device. In this setting the read flags ("L" flags) of the status object are pre-set. The output status is automatically transmitted on a change in the output manipulated variable. In addition the status of all outputs is transmitted after bus power restoration.
Summer/winter mode switch over	Yes No	Two different operating modes allow different manipulated variable setpoints to be set up for emergency mode and for forced position depending on the time of year. The parameter enables the operating mode changeover. The operating mode changeover is enabled. It can switch between summer and winter mode. The operating mode changeover is deactivated. Only one value each can be given for emergency mode and for positive operation.
Polarity of object: "Summer / winter switch over"	Summer = 1 / winter = 0 Summer = 0 / winter = 1	Determines the polarity of the object "Switch over". <i>Only if "Summer mode / winter mode switch over" = "Yes"!</i>

<p>Operating mode after commissioning</p>	<p>Winter mode</p> <p>Summer mode</p>	<p>After programming the actuator and after bus power restoration the parameter can determine the pre-set operating mode.</p> <p>After commissioning, winter mode is activated.</p> <p>After commissioning, summer mode is activated.</p> <p><i>Only if "Changeover summer mode / winter mode" = "Yes"!</i></p>																																		
<p>Feedback of the "largest manipulated variable"? (only for 8 bit manipulated variables)</p>	<p>Yes</p> <p>No</p>	<p>For boilers with certain calorific outputs the information of the largest heating manipulated variable can be necessary to determine the optimum flow temperature of the heating circuit. The size of the active 1 byte manipulated variable setpoint in the actuator is determined and, if the feedback function is enabled, is transmitted on the bus.</p> <p>Feedback of the "largest manipulated variable" is enabled.</p> <p>Feedback of the "largest manipulated variable" is disabled.</p>																																		
<p>Cycle time of the PWM period (only for 1 byte manipulated variables)</p>	<table border="0"> <tr><td>0.5 min</td><td>8,5 min</td></tr> <tr><td>1 min</td><td>9 min</td></tr> <tr><td>1.5 min</td><td>9.5 min</td></tr> <tr><td>2 min</td><td>10 min</td></tr> <tr><td>(e. g. for a only one radiator)</td><td>11 min</td></tr> <tr><td>2.5 min</td><td>12 min</td></tr> <tr><td>3 min</td><td>13 min</td></tr> <tr><td>3.5 min</td><td>14 min</td></tr> <tr><td>4 min</td><td>15 min</td></tr> <tr><td>4.5 min</td><td>(e. g. underfloor heating / multiple radiators)</td></tr> <tr><td>5 min</td><td></td></tr> <tr><td>5.5 min</td><td></td></tr> <tr><td>6 min</td><td>16 min</td></tr> <tr><td>6.5 min</td><td>17 min</td></tr> <tr><td>7 min</td><td>18 min</td></tr> <tr><td>7.5 min</td><td>19 min</td></tr> <tr><td>8 min</td><td>20 min</td></tr> </table>	0.5 min	8,5 min	1 min	9 min	1.5 min	9.5 min	2 min	10 min	(e. g. for a only one radiator)	11 min	2.5 min	12 min	3 min	13 min	3.5 min	14 min	4 min	15 min	4.5 min	(e. g. underfloor heating / multiple radiators)	5 min		5.5 min		6 min	16 min	6.5 min	17 min	7 min	18 min	7.5 min	19 min	8 min	20 min	<p>The parameter "cycle time" is active exclusively for pulse width modulated outputs.</p> <p>The cycle time determines the switching frequency of the pulse width modulated signal and thus permits it to be matched to the setting cycle time (movement time which the drive requires to move the valve from the fully closed position to the fully open position) of the actuator drives that are used. In addition to the setting cycle time, the dead time (switch on / switch off time during which actuator drive shows no response) must also be taken into account. If different drives with different setting cycle times are used, the longest time should be taken. (see "1. Actuating the outputs / pulse width modulation (PWM) – cycle time", page 11)</p>
0.5 min	8,5 min																																			
1 min	9 min																																			
1.5 min	9.5 min																																			
2 min	10 min																																			
(e. g. for a only one radiator)	11 min																																			
2.5 min	12 min																																			
3 min	13 min																																			
3.5 min	14 min																																			
4 min	15 min																																			
4.5 min	(e. g. underfloor heating / multiple radiators)																																			
5 min																																				
5.5 min																																				
6 min	16 min																																			
6.5 min	17 min																																			
7 min	18 min																																			
7.5 min	19 min																																			
8 min	20 min																																			

Parameter		
Description:	Values:	Commentary:
 Monitoring		
Monitoring of the manipulated variable?	<p>enabled</p> <p>disabled</p>	<p>The actuator is in the position to monitor the manipulated variable telegrams that it receives for instance from a room thermostat (1 bit or 1 byte). The parameter enables the monitoring function.</p> <p>The monitoring function and thus the object "cyclic monitoring of manipulated variables" is enabled.</p> <p>The monitoring function is disabled. The object "cyclic monitoring of manipulated variables" is deactivated.</p>
Monitoring time at cyclical monitoring of the manipulated variables	<p>33 s 11 min</p> <p>1 min 16 min</p> <p>2.2 min 22 min</p> <p>4.4 min 30 min</p> <p>5.5 min 45 min</p> <p>7.7 min 60 min</p>	<p>Monitoring time for cyclic monitoring of the manipulated variables. The time set here should match the time for cyclic transmission of manipulated variables by the controller.</p> <p><i>Only when "Enable monitoring of the manipulated variables?" = "enabled"!</i></p>
Polarity of object: cyclical monitoring of manipulated variables	<p>Object value if manipulated variable missing = 0</p> <p>Object value if manipulated variable missing = 1</p>	<p>Determines the polarity of the object "cyclical monitoring of manipulated variables".</p> <p>Only when "Enable monitoring of the manipulated variables?" = "enabled"!</p>
Alarm message at power failure?	<p>Yes</p> <p>No</p>	<p>For activation of the actuator drives, the actuator requires mains voltage at the outputs. If this is not present, the drive will take up its normal position (open / closed when deenergised). So that a mains power failure does not pass unnoticed at the actuator, a mains power failure message can be transmitted on the bus by the object "Alarm message mains power failure".</p> <p>The alarm message at mains power failure and thus the object "Alarm message mains power failure" is enabled.</p> <p>The alarm message at mains power failure is disabled. The object "Alarm message mains power failure" is deactivated.</p>
Polarity of object "Power failure"	<p>Object value at mains power failure = 0</p> <p>Object value at mains power failure = 1</p>	<p>Determines the polarity of the object "mains power failure".</p> <p><i>Only when "Alarm message at mains power failure" = "Yes"!</i></p>

Parameter		
Description:	Values:	Commentary:
 Emergency mode		
Manipulated variable at summer emergency mode*	<p>0 % 60 %</p> <p>10 % 70 %</p> <p>20 % 80 %</p> <p>30 % 90 %</p> <p>40 % 100 %</p> <p>50 %</p>	<p>Sets the manipulated variable setpoint when emergency mode activated (during summer mode)*.</p> <p><i>*: "Summer" only when mode changeover is enabled!</i></p> <p><i>*: Only when mode changeover is enabled!</i></p>

Manipulated variable at winter emergency mode	0 %	60 %	Sets the manipulated variable setpoint when emergency mode activated during winter mode. <i>Only when mode changeover is enabled!</i>
	10 %	70 %	
	20 %	80 %	
	30 %	90 %	
	40 %	100 %	
	50 %		

Parameter			
Description:	Values:		Commentary:
 Output 1			
Mode of operation of valve / valve drive combination	Current-free closed Current-free open		Determines whether the activated drive is closed (NC) or open (NO) in the deenergised state.
Type of manipulated variable	Switching (1 bit) Continuous (pulse width modulated 1 byte)		Sets the size of the manipulated variable object. In normal mode the switching telegram received through the object "output 1" is forwarded directly to output 1 of the actuator based on the parameter "Valve in the deenergised state". A manipulated variable received by the object "Output 1" in normal mode is converted by the actuator into an equivalent pulse width modulated switching signal at the output.
Cyclical monitoring of the manipulated variable	enabled disabled		Output 1 can be assigned to the cyclic monitoring of the manipulated variables, if the monitoring is enabled (parameter "Enable monitoring of the manipulated variables?" = "Enabled" on the parameter card "monitoring"). Output 1 is assigned to the cyclic monitoring of the manipulated variables. Output 1 is not assigned to the cyclic monitoring of the manipulated variables.
Forced position?	enabled disabled		The output 1 can be assigned to the forced position function. The output 1 is assigned to the forced position - function. The object "positive operation" is enabled. The output 1 is not assigned to the forced position function. The object "positive operation" is disabled.
Manipulated variable at summer forced position* *: "Summer" only when mode changeover is enabled!	0 % 10 % 20 % 30 % 40 % 50 %	60 % 70 % 80 % 90 % 100 %	Sets the manipulated variable setpoint to enable forced position (during summer mode)*. This parameter is always visible, irrespective of the parameter "Forced position?", since the value for forced position (summer)* can be activated even during bus power failure or after bus power restoration! *: <i>Only when mode changeover is enabled!</i>
Manipulated variable at winter forced position	0 % 10 % 20 % 30 % 40 % 50 %	60 % 70 % 80 % 90 % 100 %	Sets the manipulated variable setpoint to enable forced position during winter mode. This parameter is always visible, irrespective of the parameter "Forced position?", since the value for forced position (winter) can be activated even during bus power failure or after bus power restoration! <i>Only when mode changeover is enabled!</i>

<p>Behaviour on bus power failure</p>	<p>No reaction</p> <p>Valve closes</p> <p>Valve opens</p> <p>Manipulated variable of forced position</p> <p>Manipulated variable of emergency mode</p>	<p>The behaviour in the event of bus voltage failure is programmable.</p> <p>The manipulated variable setpoint active for the output 1 before the bus power failure (including forced position / emergency mode) remains set after the bus power failure.</p> <p>Depending on the parameter "Valve in current-free status" the output 1 is either energised or not energised, so that the activated drive closes.</p> <p>Depending on the parameter "Valve in current-free status" the output 1 is either energised or not energised, so that the activated drive opens.</p> <p>The programmed value held under "Value for Forced position" is adopted as the manipulated variable setpoint, depending on the operating mode.</p> <p>The programmed value held under "Value for emergency mode" on the parameter card "emergency mode" is adopted as the manipulated variable setpoint, depending on the operating mode.</p>
<p>Response to restoration of bus voltage</p>	<p>Valve closes</p> <p>Valve opens</p> <p>Manipulated variable of forced position</p> <p>Manipulated variable of emergency mode</p>	<p>The behaviour in the event of bus voltage failure is programmable.</p> <p>Depending on the parameter "Valve in current-free status" the output 1 is either energised or not energised, so that the activated drive closes.</p> <p>Depending on the parameter "Valve in current-free status" the output 1 is either energised or not energised, so that the activated drive opens.</p> <p>The programmed value held under "Value for forced position" is adopted as the manipulated variable setpoint, depending on the operating mode.</p> <p>The programmed value held under "Value for emergency mode" on the parameter card "emergency mode" is adopted as the manipulated variable setpoint, depending on the operating mode.</p>
<p>Object "Overload / Short circuit"?</p>	<p>enabled</p> <p>disabled</p>	<p>The actuator has a short circuit / overload detection whereby after a set detection time a short-circuited or permanently overload output can be deactivated. Short circuit / overload - detection is always active when an output is switched on. In addition can this parameter can be enabled separately for output 1, determining whether a short circuit / overload message is sent on the bus by the object "Overload / Short circuit".</p> <p>The overload / short circuit message for output 1 is enabled.</p> <p>The overload / short circuit message for output 1 is disabled.</p>
<p>Polarity of object: "Overload / Short circuit"</p>	<p>Object value on overload / short circuit = 0 Object value on Overload / Short circuit = 1</p>	<p>Determines the polarity of the object in the event of "Overload / Short circuit".</p> <p><i>Only if "object 'Overload / Short circuit'?" = "enabled"!</i></p>

 Output 2 – 6	See output 1!
---	---------------

